

PROJECT	
TYPE	
SPECIFIER	
QUANTITY	
DATE	

TRACER 60 SURFACE

E12W0000-

base number Color Finish Lens
 Temperature Options Options

- To build a product code in our configurator select the specify button on the base model # product page
- To build a manual product code on this datasheet choose from the options listed below in blue font and add the suffix to the base model #

GENERAL

Series: Tracer
 Subseries: Tracer 60
 Brand: Unonovesette
 Division: Exterior
 Mounting Type: Surface
 Mounting Location: Wall
 Subcategory: Wall Effect

PHYSICAL

Shape: Cylinder
 Diameter (mm): 62
 Diameter (in): 2 7/16
 Height (mm): 200
 Depth (mm): 83.5
 Height (in): 7 7/8
 Depth (in): 3 5/16
 Light Distribution: Direct / Indirect
 Weight (kg): 1.35
 Weight (lbs): 2.98
 Diffuser: Extra clear tempered glass 2mm
 Fixture Finish: WHI / BLK / ASB
 Fixture Material: Brass
 Cable Details: 350mm NS20N PCP 2x0.5 mm2

ELECTRICAL

Lamp Type: LED
 Input Wattage (W): 12.5
 Total Output Wattage (W): 10
 Dimming: Non-Dimming / Phase Dimming (120Vac only) / 0-10V Dimming
 Driver Included: No
 Driver Location: Remote
 Driver Type: Constant Voltage - 120 / 277
 Driver Class: Class 2
 Input Voltage (V): 120 - 277
 Output Voltage (V): 24

LED

Color Temperature (°K): 2700 / 3000 / 4000
 Max. Delivered Lumen (lm): 1030 (3000K)
 CRI: >90 CRI
 Lamp Life (hrs): 100000
 Upon Request: Dim to Warm

OPTICAL

Optic[®]: 1010 / 1030 / 1050 / 101045 / 3030 / 3050 / 301045 / 5050 / 501045 / 10451045

RATINGS AND CERTIFICATIONS

Certified By: Certified for North American Standards
 IP rating: IP66
 IK Rating: IK08

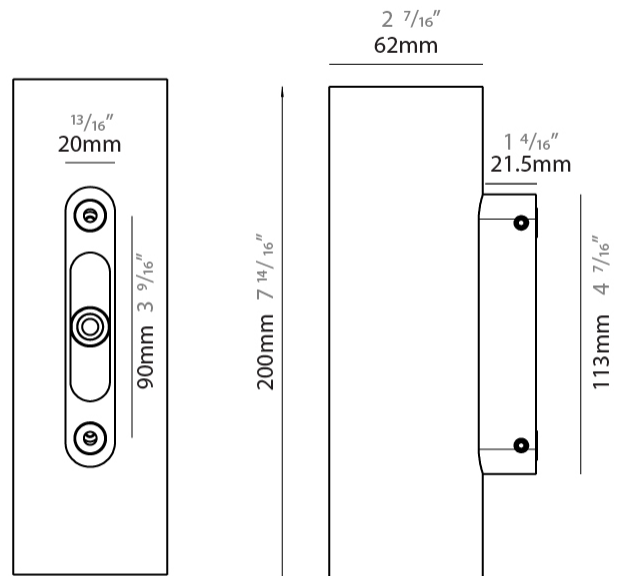

TRACER 60 SURFACE

E12W0000-

PROJECT

TYPE

SPECIFIER

QUANTITY

DATE

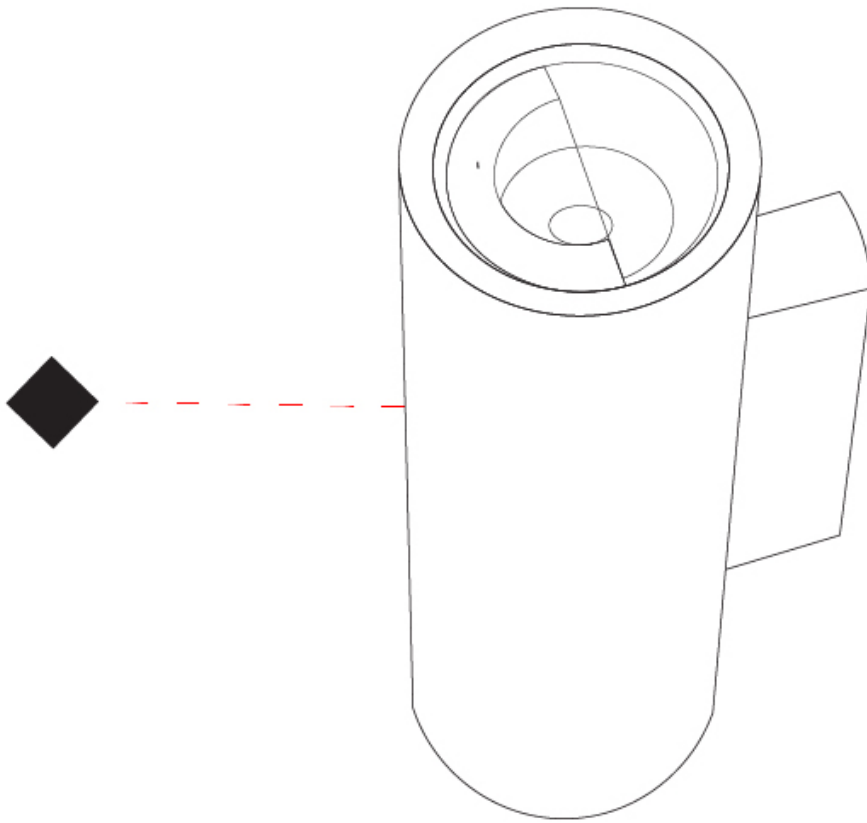

E

PROJECT	
TYPE	
SPECIFIER	
QUANTITY	
DATE	

TRACER 60 SURFACE

E12W0002-

base number Color Finish Lens
 Temperature Options Options

- To build a product code in our configurator select the specify button on the base model # product page
- To build a manual product code on this datasheet choose from the options listed below in blue font and add the suffix to the base model #

GENERAL

Series: Tracer
 Subseries: Tracer 60
 Brand: Unonovesette
 Division: Exterior
 Mounting Type: Surface
 Mounting Location: Wall
 Subcategory: Wall Effect

PHYSICAL

Shape: Cylinder
 Diameter (mm): 62
 Diameter (in): 2 7/16
 Height (mm): 200
 Depth (mm): 83.5
 Height (in): 7 7/8
 Depth (in): 3 9/16
 Light Distribution: Direct / Indirect
 Weight (kg): 1.35
 Weight (lbs): 2.98
 Diffuser: Extra clear tempered glass 2mm
 Fixture Finish: WHI / BLK / ASB
 Fixture Material: Brass
 Cable Details: 350mm NS20N PCP 2x0.5 mm2

ELECTRICAL

Lamp Type: LED
 Input Wattage (W): 19.6
 Total Output Wattage (W): 16.7
 Dimming: Non-Dimming / Phase Dimming (120Vac only) / 0-10V Dimming
 Driver Included: No
 Driver Location: Remote
 Driver Type: Constant Voltage - Universal
 Driver Class: Class 2
 Input Voltage (V): 120 - 277
 Output Voltage (V): 24

LED

Color Temperature (°K): 2700 / 3000 / 4000
 Max. Delivered Lumen (lm): 1440 (3000K)
 CRI: >90 CRI
 Lamp Life (hrs): 100000
 Upon Request: Dim to Warm

OPTICAL

Optic*: 1010 / 1030 / 1050 / 101045 / 3030 / 3050 / 301045 / 5050 / 501045 / 10451045

RATINGS AND CERTIFICATIONS

Certified By: Certified for North American Standards
 IP rating: IP66
 IK Rating: IK08

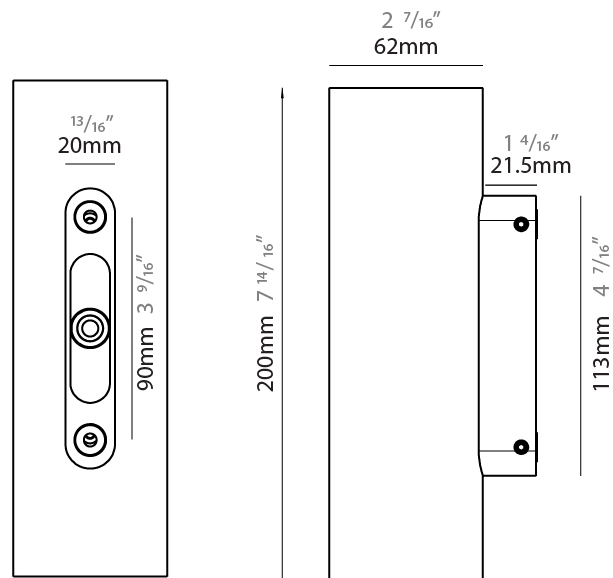

TRACER 60 SURFACE

E12W0002-

PROJECT

TYPE

SPECIFIER

QUANTITY

DATE

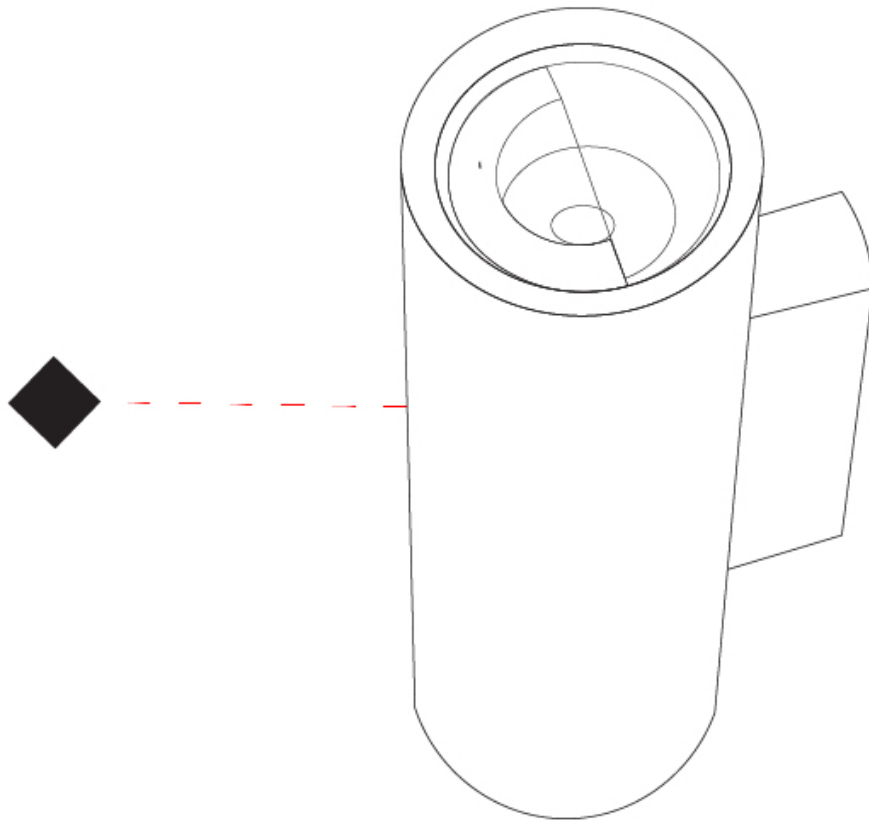

E

TRACER COLOR FINISH CHART

PROJECT _____

TYPE _____

SPECIFIER _____

QUANTITY _____

DATE _____

Fixture Finish

White - WHI



Black - BLK

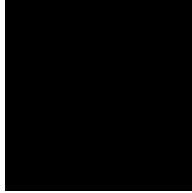

Machined aged solid brass - ASB

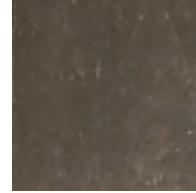

Digital: Not all screens are calibrated the same, and therefore, colors will appear differently between screens.

Physical: When texture is involved, there will be variations in color, character and tone within a product series and between product families.



PROJECT	
TYPE	
SPECIFIER	
QUANTITY	
DATE	

LEGEND

floor-mounted	pivotal	special LED (upon request) RGB, RGBW, tunable, gold+, meat+, art+, fashion+
wall and ceiling: recessed and surface mounted	rotating	warm dim / natural dimming LED
ceiling-mounted and wall-mounted	illuminate tilted	rechargeable battery powered
wall-mounted	color of suspension cable	fixture with natural vivid LED (upon request)
omni-directional light distribution	length of suspension cable	color rendering index
direct light distribution	reflector degree selection	color temperature
direct/indirect light distribution	super spot	lumen (luminous flux)
indirect light distribution	lens	efficacy (lumens per watt)
asymmetric light distribution	lens pack	Unified Glare Rating (UGR) range from 5-40
aura light distribution	shine ring	marine grade (AISI 316 stainless steel)
round wall or ceiling cut-out	integrated shine ring with diffuser	walk on
square wall or ceiling cut-out	free individual colors 01-29	drive on
the supplied jig specifies the cutout dimensions	individual colors: 00 (free of charge), 01-25 (extra charge)	Dark Sky Compliance
minimum distance (meters) lamp - object	luminaire part to be colored (F1)	Americans with Disabilities Act (less than 4" off the wall located between 27"-84" from floor)
recessed depth	luminaire part to be colored (F2)	lamp protected against explosion
ceiling thickness in mm	luminaire part to be colored (F3)	blown glass using traditional methods by master glass blower
ceiling thickness selection	luminaire part to be colored (F4)	acoustic material
dimmable DP (phase), DV (0-10V), DD (dali), DS (step-dim)	luminaire part to be colored (F5)	protection class I, protection insulation
included or excluded LED driver/transformer/control gear	color of 3-circuit adaptor	protection class II, protection insulation
separately switchable	indirect diffuser	ETL Certified to UL and CSA Standards
sensor	direct diffuser	UL Certified to UL and CSA Standards
remote control	ball-proof (upon request)	CSA Certified to UL and CSA Standards
available upon request	accessory	Certified for North American Standards

IP RATING

IP20	protected against ingress of solid bodies greater than 12.5mm (finger)
IP33	protected against ingress of solid bodies greater than 2.5mm protected against sprays of water up to 60 degrees from the vertical (rain)
IP40	protected against ingress of solid bodies greater than 1mm (wire) no protection against the ingress of moisture
IP43	protected against ingress of solid bodies greater than 1mm (wire) protected against sprays of water up to 60 degrees from the vertical (rain)
IP44	protected against ingress of solid bodies greater than 1mm (wire) protected against water splashed from all directions
IP54	protected against limited ingress of dust (wet rooms/covered outdoor areas) protected against water splashed from all directions
IP65	protected against ingress of dust protected against jets of water
IP66	protected against ingress of dust protected against powerful jets of water or heavy seas
IP67	protected against ingress of dust protected against immersion of water between 15cm - 1m for 30 minutes
IP68	protected against ingress of dust protected against immersion of water under pressure for long periods

IK RATING

IK01	protected against 0.14 joules impact (equivalent to 0.25kg mass dropped from 56mm above the surface)
IK02	protected against 0.2 joules impact (equivalent to 0.25kg mass dropped from 80mm above the surface)
IK03	protected against 0.35 joules impact (equivalent to 0.25kg mass dropped from 140mm above the surface)
IK04	protected against 0.5 joules impact (equivalent to 0.25kg mass dropped from 200mm above the surface)
IK05	protected against 0.7 joules impact (equivalent to 0.25kg mass dropped from 280mm above the surface)
IK06	protected against 1 joules impact (equivalent to 0.25kg mass dropped from 400mm above the surface)
IK07	protected against 2 joules impact (equivalent to 0.5kg mass dropped from 400mm above the surface)
IK08	protected against 5 joules impact (equivalent to 1.7kg mass dropped from 300mm above the surface)
IK09	protected against 10 joules impact (equivalent to 5.0kg mass dropped from 200mm above the surface)
IK10	protected against 20 joules impact (equivalent to 5.0kg mass dropped from 400mm above the surface)